

**ALLEGATO VIII: Tavole**

Nuovo impianto/reimpianto con filari paralleli confinanti con area sensibile (art. 1 c. 6)

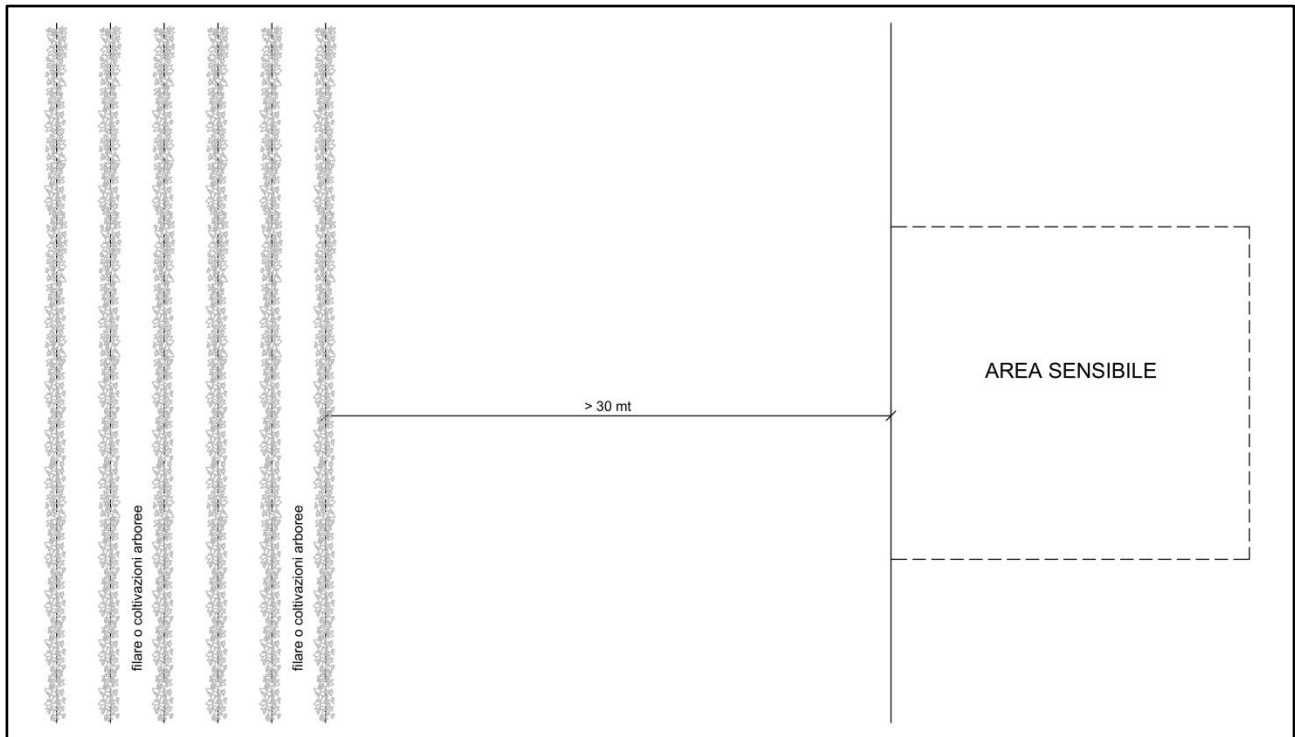
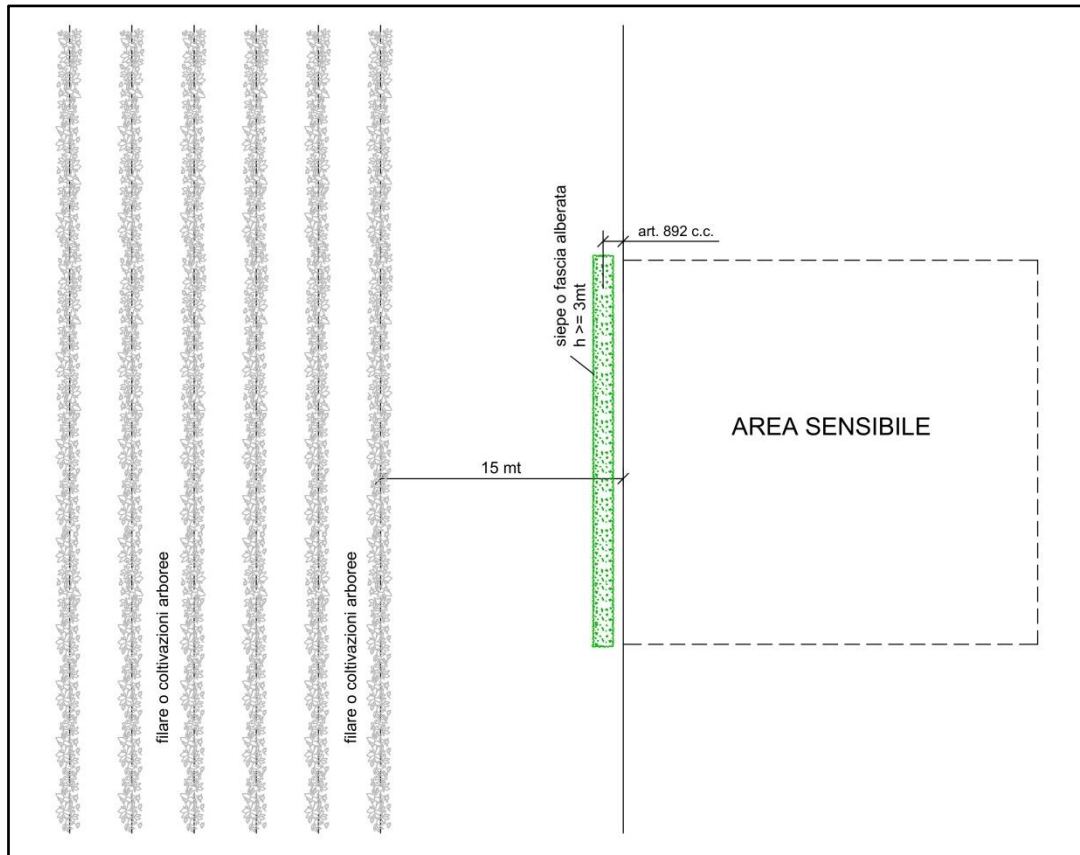

**ALLEGATO VIII: Tavole**

Nuovo impianto/reimpianto con filari perpendicolari confinanti con area sensibile (art. 1 c. 6)

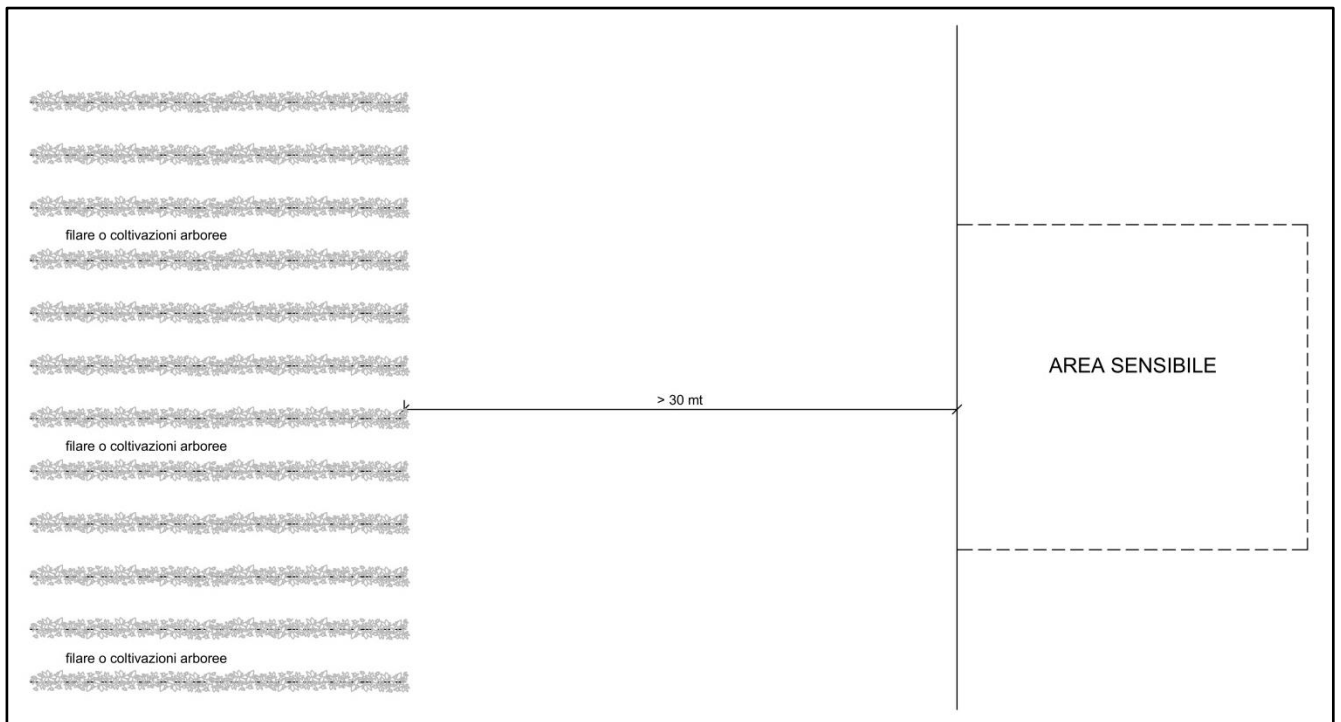
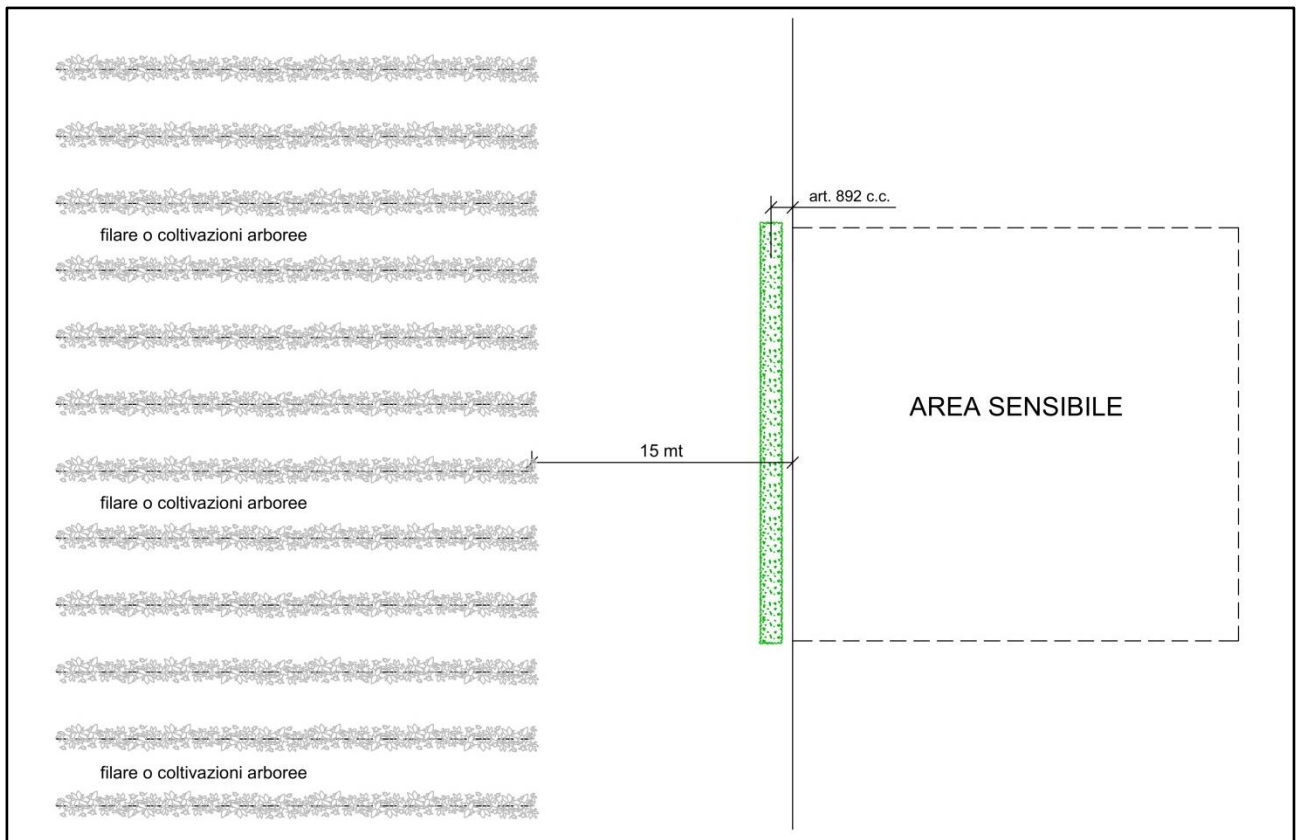

**ALLEGATO VIII: Tavole**

**Nuovo impianto/reimpianto con filari paralleli confinanti con altre aree**

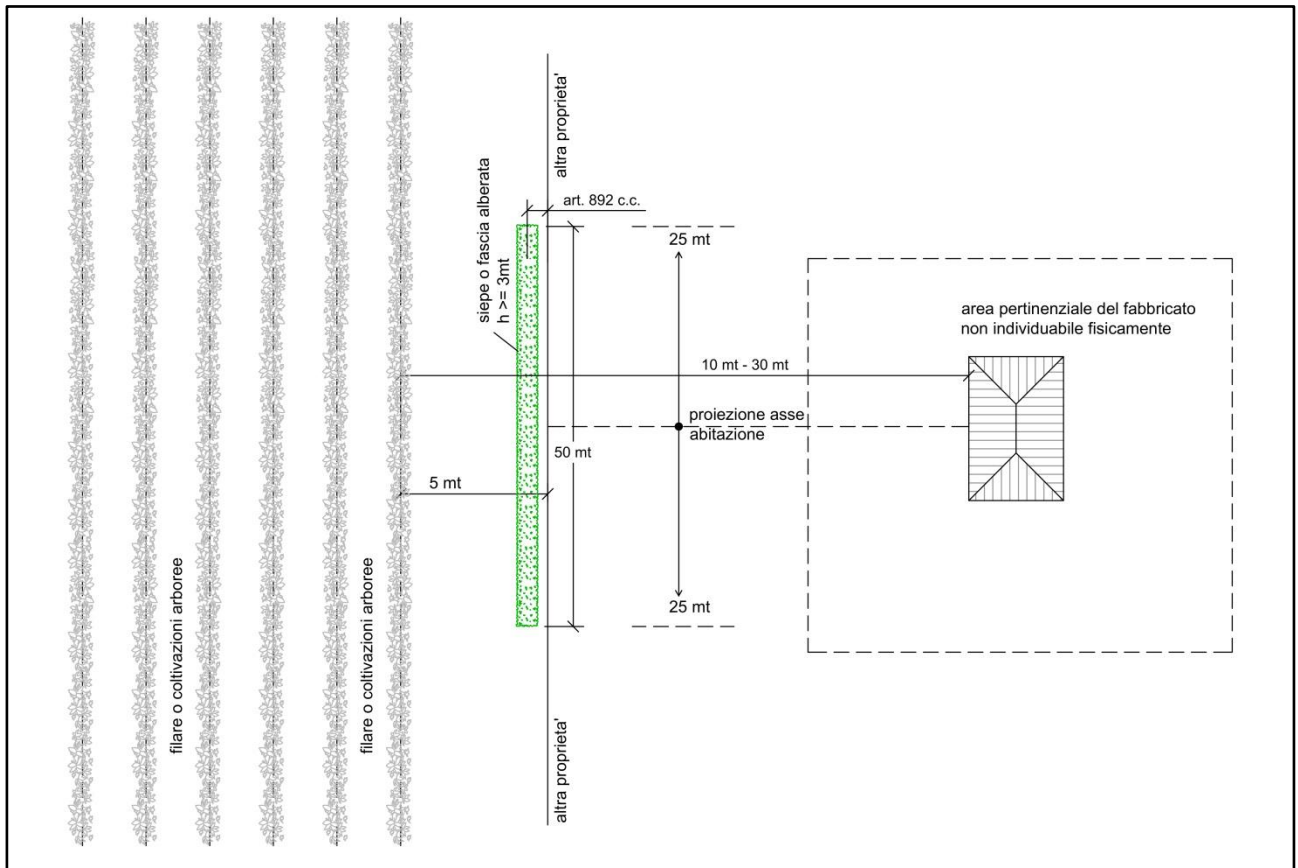
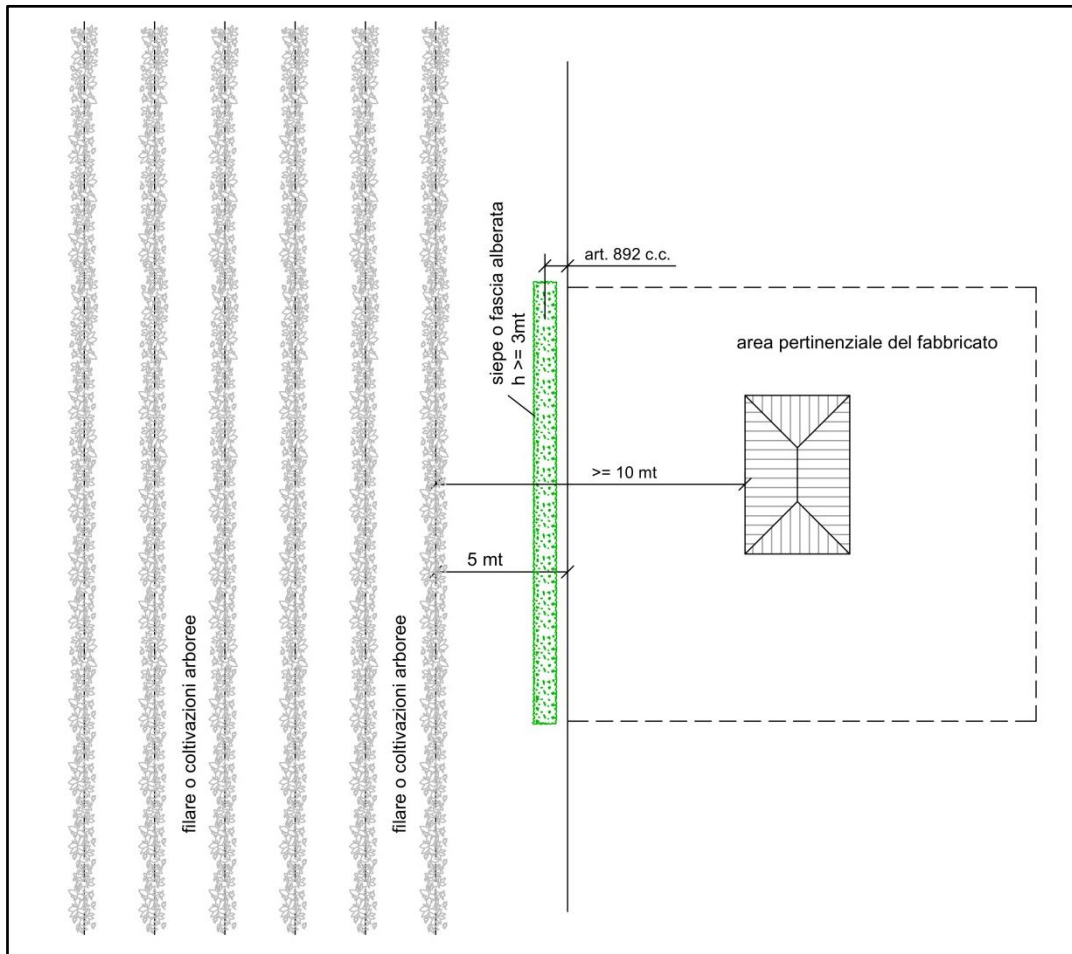

**ALLEGATO VIII: Tavole**

**Nuovo impianto/reimpianto con filari perpendicolari confinanti con altre aree**

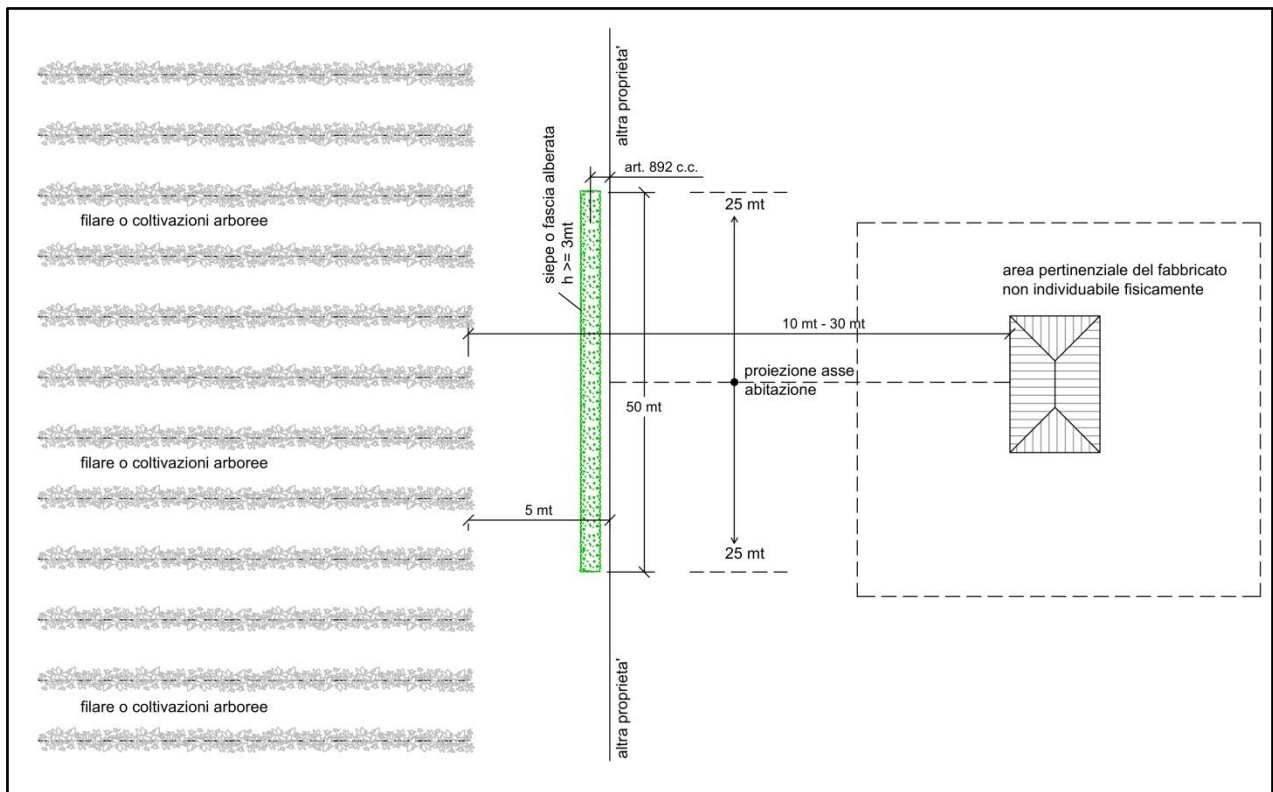
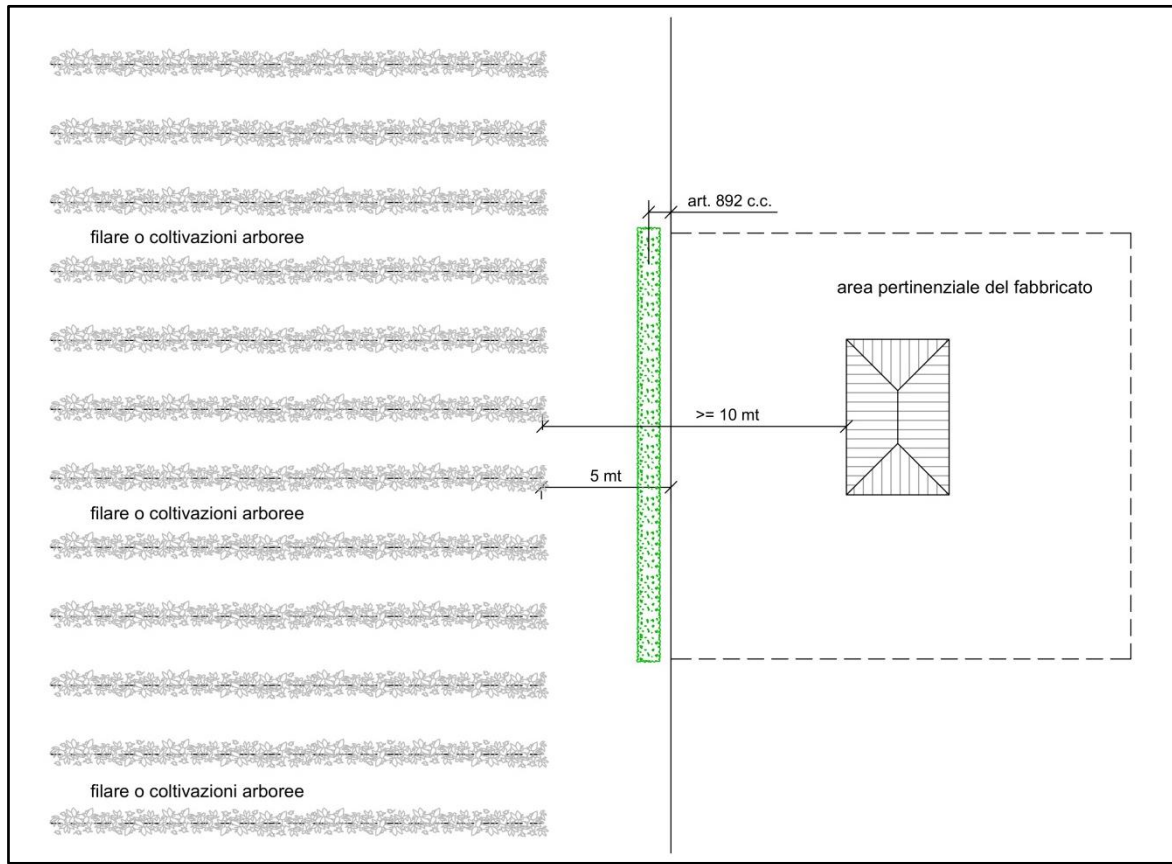

**ALLEGATO VIII: Tavole**

**Nuovo impianto/reimpianto con filari paralleli confinanti con altre aree – DEROGA SIEPE**

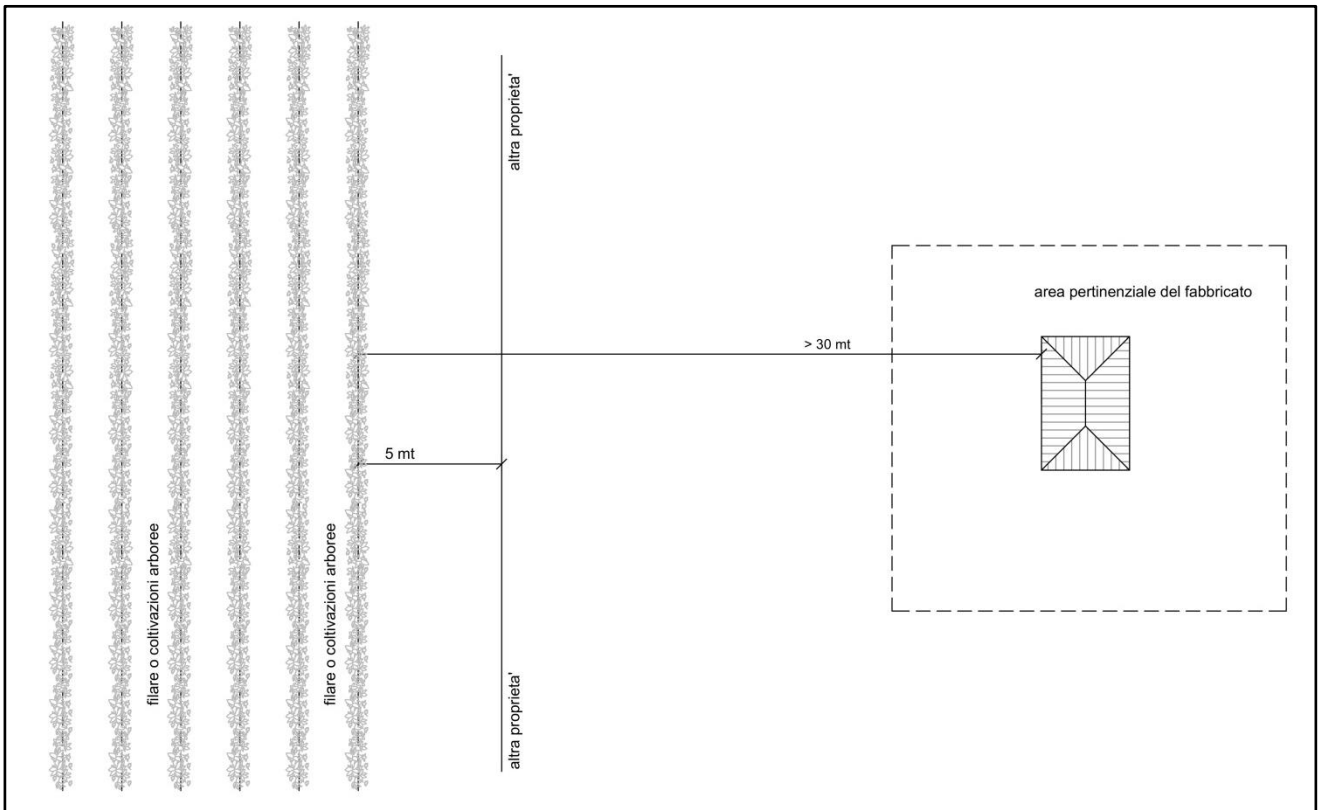

**Nuovo impianto/reimpianto con filari perpendicolari confinanti con altre aree – DEROGA SIEPE**

